

Central Control Unit



Watts V24

User Guide**GB***Wireless Central Control Unit*

3 -38



IMPORTANT!

The installation and connection of the control unit must only be carried out by a person with relevant qualifications. Before starting work, this person should carefully read this Installation and Operation Manual, and make sure all instructions contained therein are understood and observed. After finishing the installation and connection, he/she is obliged to familiarize the user with the functions of and way of using the appliance and hand over this Installation and Operation manual.

The Installation and Operation Manual is an inseparable part of the product. The user should read all the instructions and follow the instructions contained therein when programming and using the control unit.

For safety reasons, no additional modifications to the product are allowed. Possible repairs/modifications can only be carried out by service centres approved by the manufacturer. The producer shall not be liable for defects caused by unauthorized alterations made to the product, incorrect or faulty installation, or its use in a manner which is in conflict with this Installation and Operation Manual.

USE

- The control unit is intended for use in controlling all types of electric heating systems in combination with "BT xx 02" (Watts V22/23/25/27) wireless regulation
- The product is designed for use in family homes and flats, office and administrative buildings, schools, doctor's surgeries, etc.

To ensure correct operation, check that heating and electrical systems comply with current regulations before use.



SAFETY INSTRUCTIONS

Before starting work, disconnect the power supply!

- All installation and wiring work related to the control unit must be carried out only when the power supply has been disconnected. The appliance should be connected and commissioned by qualified persons only. Make sure that valid safety regulations are observed.
- The thermostats have an IP 30 rating – they can be installed only in interior locations and in zones which comply with the appropriate regulations.
- Do not mix up the connections of the sensors and the 230V power connections under any circumstances! Mixing up these connections may result in a life endangering electrical hazard or the destruction of the appliance and connected sensors, or other appliances.

Contents

1	Description	6
2	First Installation	7
2.1	Connection to the power supply.....	7
2.2	Basic settings	7
2.3	Wireless connection of zones (pairing).....	9
3	The appearance of the main screen and options	14
3.1	Main settings menu	14
3.1.1	Vacation Settings	14
3.1.2	INSTALLATION.....	16
3.1.3	PAIRING – adaptation and cancellation of zones	20
3.1.4	GSM – control via a mobile network	21
3.1.5	MODE – Heating mode	24
3.1.6	RESET	25
3.1.7	Statistics	26
3.2	Zone menu	28
3.2.1	Installation 1:	28
3.2.2	Installation 2:	34
3.3	Information Function	36
4	Technical Characteristics	37

1 Description

- A wireless central unit specially designed to control and monitor your heating system.
- Convenient control from one place via a touch screen
- Easy use in a user-friendly environment.
- Economical operation thanks to the option of an individual 1-week programme for each zone
- The option of controlling up to 24 zones at once (zones can be named for easier orientation).
- 30-day energy consumption statistics for each zone
- Simple installation – the control unit is only connected to the power source
- The option of controlling the unit via text messages using the GSM V27 unit.



2 First Installation

2.1 Connection to the power supply

When connecting the central unit for the first time, aside from the setting of basic parameters (date, time, etc.) it is also necessary to provide a power supply for the V24 central unit for a period of least 24 hours in order for the back-up source to reach maximum capacity.

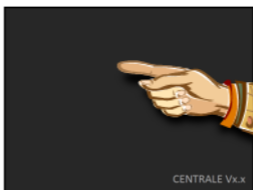

One short
press to skip

2.2 Basic settings

Choose the language by moving the flag which symbolizes the required language to the central position (framed blue) – either using the arrows next to the flags (1) or by pressing the flag directly (2). After making the selection, press the arrow (3) in the right bottom corner (forwards) to enter the next settings screen.

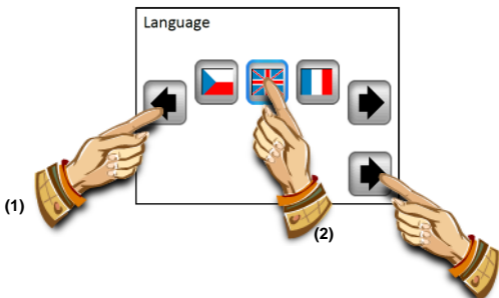

Select the required temperature scale by pressing the relevant button directly (the selected value is framed in blue) (3)

Continue to the next settings screen using the arrow in the bottom right corner.

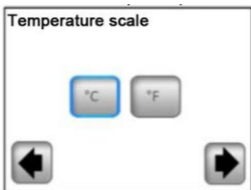

Choose the 24H/12H time format by pressing the corresponding button directly (the value chosen is framed in blue). Press the arrow in the bottom right corner to access the next settings screen.

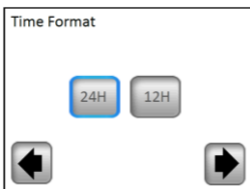

Setting the date and time – set the selected parameter (inversely backlit) using the (+) or (-) buttons; move the cursor to the next parameter using the (<)(>) buttons at the edges of the screen.

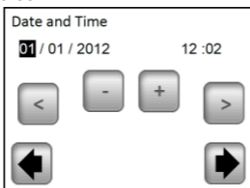

End your work with the basic settings using the arrow in the bottom right corner; you will be brought back to the main screen.



While completing the basic settings, you can always return easily to the previous menu by pressing the arrow in the bottom left corner (**back**).

2.3 Wireless connection of zones (pairing)

2.3.1 In order to easily pair your V24 central unit with other regulation elements of the heating system you have to install and connect the regulation members first (usually a V22 thermostat with a V23/25 receiver/receivers) in all the rooms/zones (usually, one room = an independent zone). Only afterwards should you start pairing your central unit with the individual zones.

2.3.2 Press the “**Settings**” button.

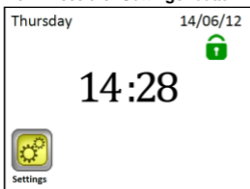

2.3.3 Press the “**Installation**” button

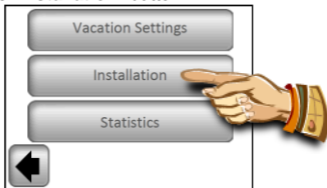

2.3.4 Press the “**Down**” button

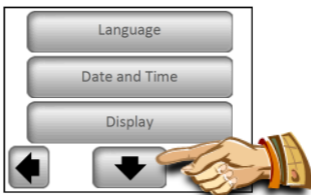

2.3.5 Press the **"Pairing"** button to access the pairing menu.

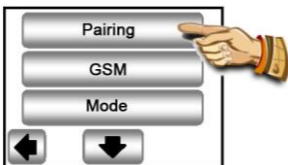

2.3.6 Press the **"New/Change Zone"** button

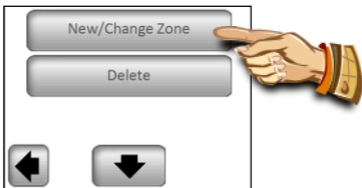

2.3.7 The display of the control unit now shows the button for the launch of pairing

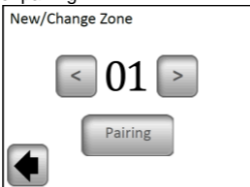

Now switch the main receiver (usually a V22 thermostat) in the given room/zone to the “RF init” mode by pressing the pairing button for a period of 3 seconds – the LED diode on the paired unit will glow green

⚠ Important:

Only the master receiver in a group – the Master to which other regulation members in the zone are connected (see point 2.3.1) – may be linked to the central control unit.

2.3.8 For pairing with a receiver, press the “Pairing” button on the central unit

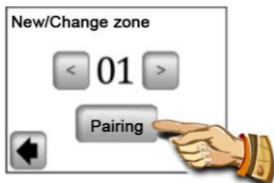

The control unit searches for a receiver in the “RF ini” mode



Confirmation of a successful connection is shown on the display for 5 seconds



2.3.9. Now you can configure the name of the zone which has just been connected



Choose the name of the zone from the pre-set names by using the (<) or (>) buttons.

You can choose from the following options:

Bedroom, Kitchen, Bathroom, Dining Room, Living Room, Hall, Study, Playroom, Corridor, Loo, Cellar, Garage, Attic and Other.

You can supplement the name for the zone with a number ranging from 0 to 9 (0 = no number will be displayed behind the name).

2.3.10 Press the "OK" button to finish the pairing



Now, you will be offered the option of pairing another zone. To configure other zones, repeat steps 2.3.7 to 2.3.10

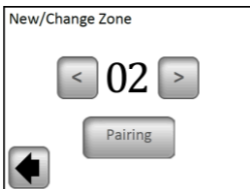

Or, finish the pairing by returning to the main screen by pressing the arrow in the bottom left corner (**back**) repeatedly

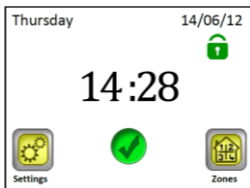

3 The appearance of the main screen and options

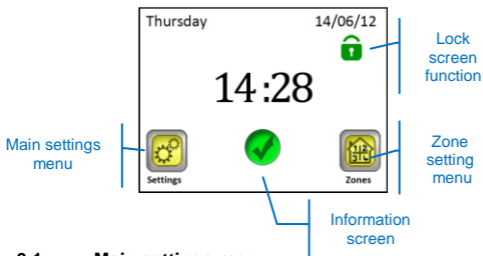

3.1 Main settings menu

Press the “**Settings**” button to enter the main settings menu.



3.1.1 Vacation Settings

Press the “**Vacation Settings**” in the main settings menu. You can choose from three operating modes on the following screen:

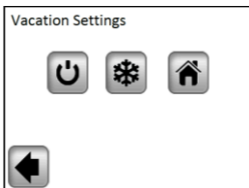



OFF Mode: Your whole heating system will be switched off.



Important: If this mode is used in the winter period, there is a danger of the temperature dropping below freezing point in the building and the subsequent occurrence of damage – give preference to the Non-freezing mode in this period.



Non-Freezing Mode: All zones will maintain the set non-freezing temperature – a different value can be set for each zone.



At Home: The same programme mode as is set for Sunday will be maintained in all zones until the date of return (see chapter 3.2.). This setting is usually used in cases when you stay at home during your holiday and the building is used in a similar way as on Sunday for the whole period.

Select the required mode for the duration of your holiday by pressing the corresponding symbol (1). The button will be highlighted. Then set the date of return by pressing the “**Set Return Date**” (2) button.

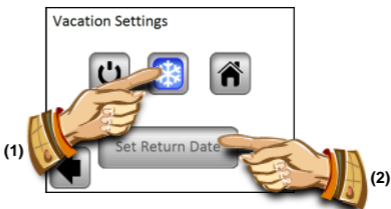

Once your return date has been set, press the **(OK)** button in the bottom part of the screen to confirm your settings and finish - the display will show the selected mode (OFF/Non-freezing mode) and the date when the settings will stop being used.

You can easily end the Vacation mode before the set return date by pressing the button for the selected mode...



... and pressing the "STOP" button.

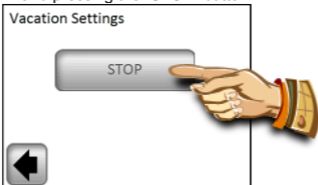

Note: In the "At Home" mode, the main screen is displayed enabling access to all functions, supplemented by a "Holiday" symbol with the date of return. You can stop the mode earlier by pressing the symbol, and then pressing the displayed "STOP" button.



3.1.2 INSTALLATION

Press the "Installation" button in the main settings menu.

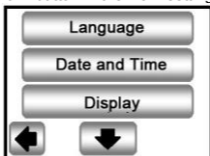

3.1.2.1 Settings – Language

The “**Language**” button enables the language settings to be changed – see Chapter 2.2. ‘Basic settings’.

3.1.2.2 Settings – Date and Time

The “**Date and Time**” button enables date and time to be changed – see Chapter 2.2 ‘Basic settings’.

By pressing the “**ADVANCED**” button, you can activate the Daylight Saving Time function. The selected button is framed in blue.



For settings where the selected parameter is marked with a blue frame, the selection doesn't need confirming and you can exit the menu with the help of the arrow in the bottom left corner (**back**).

3.1.2.3 Settings – Display

The setting of the temperature scale (A) and the setting of display characteristics (B) are available when the “**Display**” button is pressed. The selected value is framed in blue.

A) Setting of temperature scale

- 1) “Temperature Scale” – selection of a temperature scale
 - °C – for degrees Celsius
 - °F – for degrees Fahrenheit
- 2) “Time format” – selection of the time display method
 - 24H – 24-hour cycle
 - 12H – 12-hour AM/PM cycle

B) Setting of display characteristics:

- 1) “**Colour**” – selection of backlight colour – None/Grey/Blue/Red
- 2) “**Clean display**” – after pressing the button the display will remain inactive for 10 seconds, which enables it to be cleaned with a suitable cleaning agent

3) **"Display lock"** – selection of automatic or manual locking for the touch screen

3a) Display lock – **Manual mode**

Press the small padlock icon on the main screen.



On the following screen, press the **"Lock"** button for 5 seconds to lock the display.

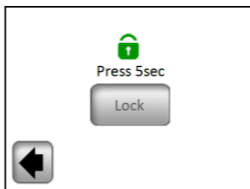

The locking of the display is signalled by a red padlock icon. You can activate the display by pressing this icon for a period of 5 seconds.

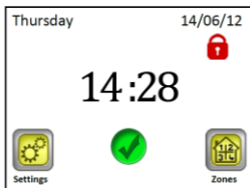

3b) Display lock - **Automatic mode**

The display is automatically deactivated after 5 minutes of inactivity from the user; the locking of the display is signalled by a red padlock icon. You can activate the display by pressing the icon for a period of 5 seconds. After five minutes of inactivity from the user, the display is automatically deactivated again.

4) **"Screen saver"** - switches the screen saver on/off

4a) Screen saver – **NO** – the screen saver is deactivated

After 1 minute of inactivity from the user, the luminosity of the display always decreased to 50%. Between 20:00 and 06:00, the luminosity of the display decreases by 50% after one minute of inactivity from the user, and after a further 9 minutes of such activity the display goes completely dark.

4b) Screen saver – **YES** – the screen saver is active

After 1 minute of inactivity from the user, the luminosity of the display decreases to 30% and the screen saver is displayed.

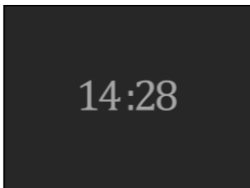

Between 20:00 and 06:00, the luminosity of the display is decreased to 30% after 1 minute of user inactivity, and after another 9 minutes of such inactivity, the display goes completely dark.

3.1.3 PAIRING – adaptation and cancellation of zones



The “**New/Change Zone**” zone button enables new zones to be added or current zones to be altered/changed. The pairing procedure is described in Chapter 2.3.



To aid orientation, zones which are already being used are marked in red.

The “**Delete**” button is used to cancel a selected zone.



Select the zone to be deleted using the (<) or (>) buttons and press the “**Delete**” button. Confirmation of the deletion by pressing the “**YES**” button is required in order to avoid the undesired deletion of a zone.

3.1.4 GSM – control via a mobile network

The main screen with a connected GSM module

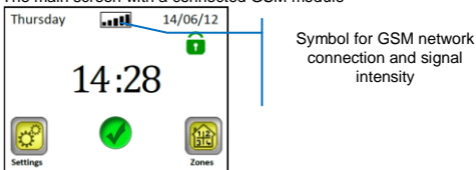

The setting up of GSM communication is only possible with a connected V27 GSM module (wired or wireless).

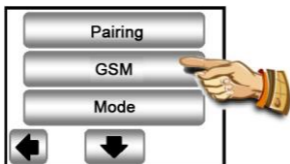

If wireless communication is used between the V24 control unit and the V27 module, connection (pairing) of both units will need to be carried out first.



1. Switch the auxiliary RF antenna of your GSM module to the pairing mode (RF init) by pressing the RF button for a period of 3 seconds. The LED diode on the antenna will start glowing green. Now press the **"Pairing"** button on your central unit and the pairing of both units will take place.



2. Confirmation of a successful connection is displayed for 5 seconds on the screen.



Now set the GSM module using the "Configuration submenu".

Screen 1,



Screen 2,



a) Phone Number

This menu is used to fill in the phone number to which short text messages about the status of the heating system will be sent.

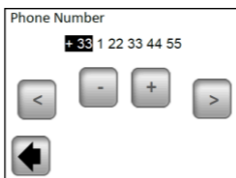

Important:

Use always the international format with the corresponding index for your country for the phone number.

b) GSM Test

You can check the setting of the phone number by sending a test message via pressing the "GSM Test" button.

c) Alarm Zones

Activate this function by pressing the "Yes" button if you wish to receive text messages regarding error reports from one of the zones (flat batteries, a problem with the receiver...)



Only 1 text message will be sent for each error report to inform you that you need to check the corresponding zone.

d) Temperature & Temperature Level Alarm

Activate this function by selecting a zone or the whole building ("All") if you wish to receive a text message if the room temperature drops under the set level. Depending on your choice, the function will be active only for a selected zone or for the whole building – a text message will be sent to inform you if the temperature drops in any of the zones.

Choose "No" if you wish to deactivate this function.

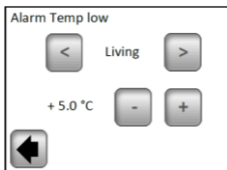

⚠ Important:

If the control unit is in the “Off” mode (see Chapter 3.1.1), the “Low Temperature Alarm” will be deactivated.

If the control unit is in another special mode (Vacation, Non-freezing mode), make sure that the temperature set for the activation of the “Low Temperature Alarm” is not higher than the value set in the mode used.

e) Heart Beat

At midday, the control unit can send you a text message with information about the status of the individual zones. The period between the sending of messages can be set within a range from 01-99 days (01 – every day, 02 – every other day, etc.) You can activate this function by selecting the length of this period in days; if you choose “No” the function will be deactivated.



3.1.5 MODE – Heating mode

When programming the individual zones (see Chapter 3.2), each zone can be allocated a different operating mode. In this menu, one identical operating mode can be allocated to all zones simultaneously.

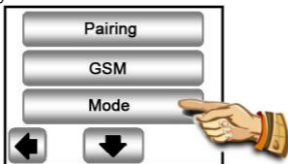

When you enter this menu for the first time, no operating mode is selected.

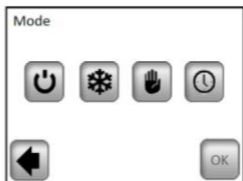

Press the required operating mode, which will highlight it, and confirm your selection by pressing the (OK) button.

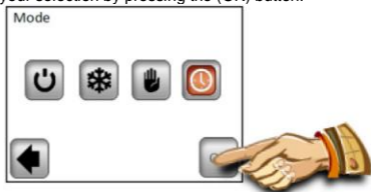

Example: "AUTO" mode will be set for all the zones



WARNING – this setting will only be applied in zones which are regulated on the basis of temperature. The setting doesn't apply to zones in which the receivers are in the ON/OFF mode.

3.1.6 RESET

Use this function to reset the unit to factory settings; all individual settings will be erased from the V24 central unit (program, zones...)



The software version is displayed in the bottom right corner.



Make sure that you have all information needed to set the parameters of the control unit and the individual zones again.

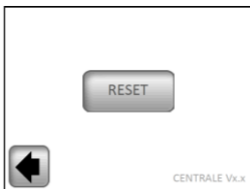

Confirm you wish to reset to factory settings by pressing the “Yes” button.



(More detailed explanation can be found in the First Installation section, Chapter 2).

3.1.7 Statistics

It is used to display the approximate consumption (in kWh) of the individual zones in the last 30 days. The wattages of the heating systems in the individual zones need to be set (see Chapter 3.2.) in order to use this function correctly.

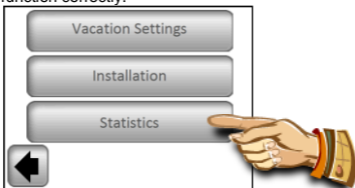

By pressing “**Display**” on the screen, the approximate consumption for the last 30 days will be displayed. The statistics will be erased by pressing “**RESET**” and confirming with “**YES**”, keeping the button pressed for a period of 5 seconds.

The image shows two screenshots of a control panel. The top screenshot displays two large buttons: "Display" and "RESET", with a back arrow button below them. The bottom screenshot shows the "Statistics" screen. It features a table of energy consumption for different zones, a "Month" label with a green triangle warning icon, and navigation buttons. Blue lines with text labels point to various elements:

- "Name of zone" points to the zone names in the table.
- "Statistics period" points to the "Month" label.
- "Move to the next page" points to the up and down arrow buttons.
- "Change the statistics period (in days)" points to the left and right arrow buttons.

Zone	Consumption
Bedroom 1	25.0Kwh
Bedroom 2	21.0Kwh
Kitchen	12.0Kwh
Living Room	36.0Kwh

 **Important note:**

 - warning regarding incompleteness, estimates, statistics (the heating system was switched off in the high tariff period, breakdowns,...)

3.2 Zone menu

The menu is used to view individual zones and their settings depending on the type of installation (combination of thermostat/receiver elements).

3.2.1 Installation 1:

Combination of a V23 (V25/V26) receiver with a V 22 thermostat.

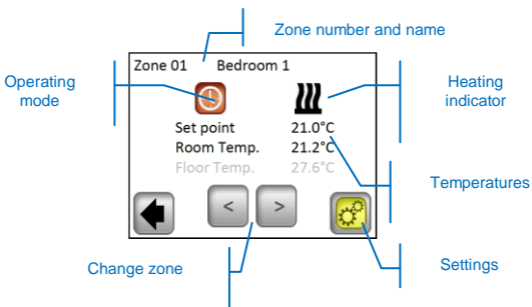

By pressing the “**Operating mode**” icon, you will have direct access to the settings of the parameters of the mode.

Settings

Setting of the heating mode and parameters of a zone.

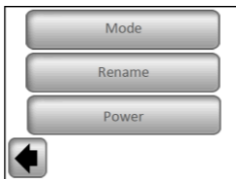

a) **Mode – heating mode**

The current operating mode is in colour, located in the middle of the screen.



To change the working mode, use the arrows or click directly on the desired mode icon.

Heating modes:



Standby mode,

- switches off the heating in a zone.



Manual mode

- maintains the manually set temperature.

The (+) or (-) buttons are used for changing the required temperature; the change can also be made on the V22 thermostat in the given zone.



Non-freezing mode

Setting the non-freezing mode for a zone.

The set temperature can be changed using the (+) or (-) buttons.



Automatic mode,

Regulation of temperature according to a selected program. The option to choose from factory pre-set programmes (P1 – P9) or an individually created programme.

By pressing the **“Program menu”**, you will go to the following screen.

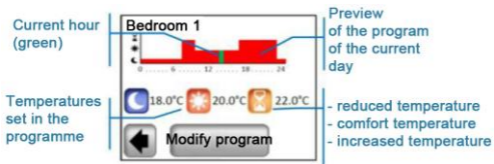

By pressing “**Modify program**”, you will have 2 options:

1 / “**Set point**” - change the Increased, Comfort or Reduced temperatures

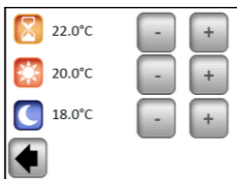

Set the required temperature values with the help of (+) or (-). Confirm or cancel the change by pressing the relevant button in the bottom part of the display.



2 / “**Program**” – preview, select or edit the current program.

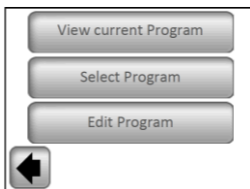

“**View current program**” – preview the program of the current day

View the program using the (<) and (>) button; go to the next day by pressing the day in the bottom right corner of the display.

“**Select program**” – the option to choose from 9 pre-set programs (P1 to P9) or your user program. The user program has the same name as your zone.

Use the (<) and (>) **buttons** to select the program.

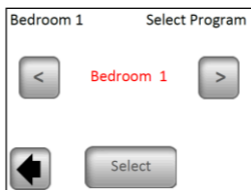

Copy the program: Copies the program of another zone by selecting it; it is automatically renamed to the same name as the current zone. The program created in this way can be subsequently altered without changing the previous program.

All user programs are automatically set to the comfort temperature for the whole day.

“**Edit program**” – edit the program in 15-minute steps with the option of choosing from three temperature values for the given section.

Select the day/days for programming. The selection will be marked with a blue frame.

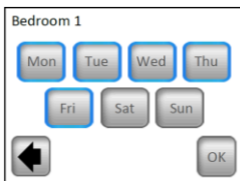

You can create the program by pressing the symbols of the individual temperatures. You can move along the time axis using (<) and (>).

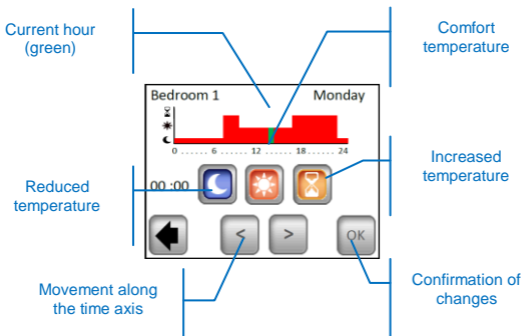

When you have finished, press the "OK" button and you will move to the program alteration option for the remaining days/day.

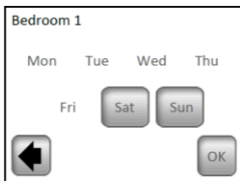

Press "OK" after all days have been programmed, thus confirming and saving the program.

Note: It is possible to re-program an already programmed day or days by pressing their name (marked with the blue frame).



You can modify the created programme at any point in the future according to the procedure described.

b) Rename

Change the name of a selected zone from the set of options; see Chapter 2.3.9.

Note : Room names/numbers marked in red have already been used for different rooms.



c) Power

Sets the wattage of the heating in a given zone (Master+Slaves) in 10W steps. The value is used in the Statistics section (see Chapter 3.1.7)

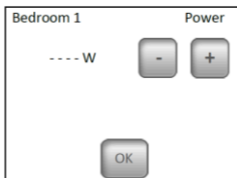

3.2.2 Installation 2:

Receiver V25 or V26 paired directly with the central unit:

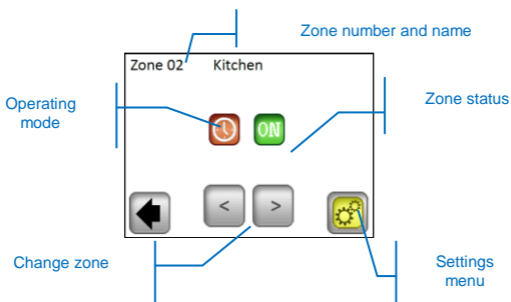

Settings menu

Configuration and setting of zone parameters.

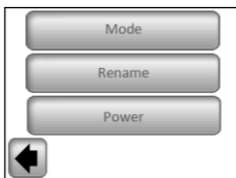

a) Mode – operating mode



Use the buttons (<) and (>) to change the operating mode or click on the required icon directly.

The current operating mode is in colour, located in the centre of the display.

Mode selection:



OFF mode,
Switch off a zone.



ON mode,
In this mode, the output of the receiver will always be activated.



Timer Mode,
The timer mode enables a receiver to be switched on for a selected period. Set with the help of (+) or (-) from 10 minutes to 5 hours, in 10 minute steps.



Automatic mode,
An On/Off 1-week programme with the option of choosing from pre-set programmes P1 – P9 or an individually created program (see Chapter 3.2.1 – “Program”)

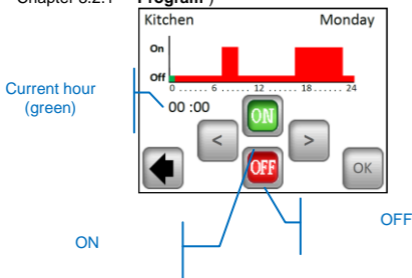

The control on the V25 receiver enables it to be set directly (On/Off, Timer 2Hours) and it takes precedence over the instructions of the central unit.

3.3 Information Function

When pressing the information symbol, a more detailed message about the status of the heating system is displayed.



Heating system and regulation are OK.

Informative message.



- the heating system was switched off (high tariff, network distribution failure)

- pilot wire signal (intended for the French market)



- Floor limitation indication when the V23 receiver is used with a floor sensor



Error message:

- error in communication with the thermostat

- error in communication with the receiver

- error/damage to the sensor of the receiver, thermostat

- GSM error, only when a V27 unit is connected

(More details about error reports can be found in the GSM V27 manual)

4 Technical Characteristics

Shipping and storage temperature:	0°C - 40°C -10°C to +50°C
Electrical Protection Type of device	IP30 Class II
Temperature precision	0.1°C
Range of temperature settings Comfort, Reduced Vacation (Non-freezing)	5°C to 37°C in 0.5°C steps 7.0°C (adjustable)
Power Supply	230VAC +/- 10% 50Hz
Radio Frequency	868 MHz, <10mW.
Software version	Shown during init./Reset: V xxx
Compatible units	V23 flush receiver V25 socket receiver V26 wall receiver V27 GSM module
Standards and homologation: The thermostat has been designed in conformity with the following standards or other normative documents:	EN 60730-1 : 2003 EN 61000-6-1 : 2002 EN 61000-6-3 : 2004 EN 61000-4-2 : 2001 EN300220-1/2 EN301489-1/3 R&TTE 1999/5/EC Low voltage 2006/95/CE EMC 2004/108/CE

CE

GB V24 Central Installation

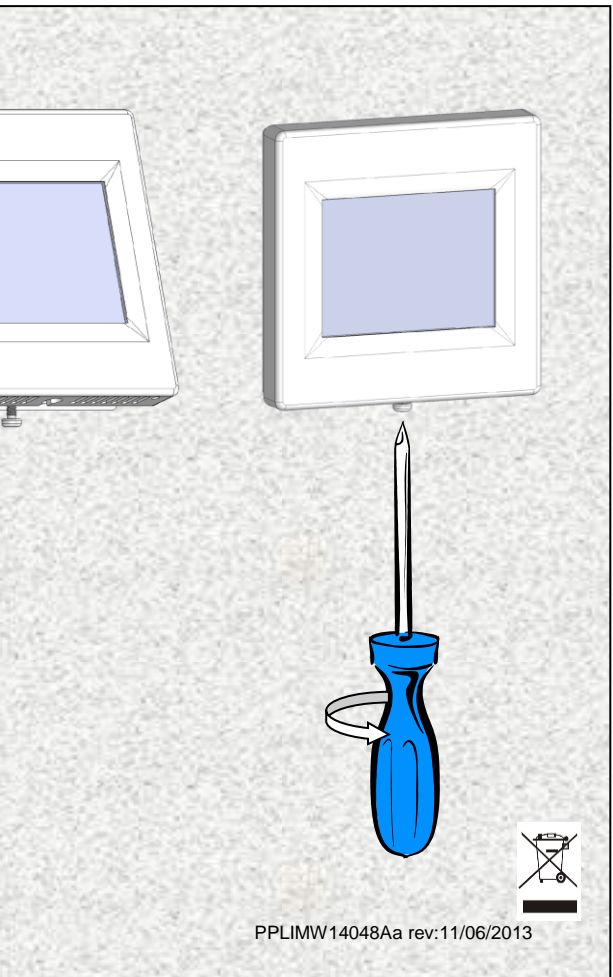
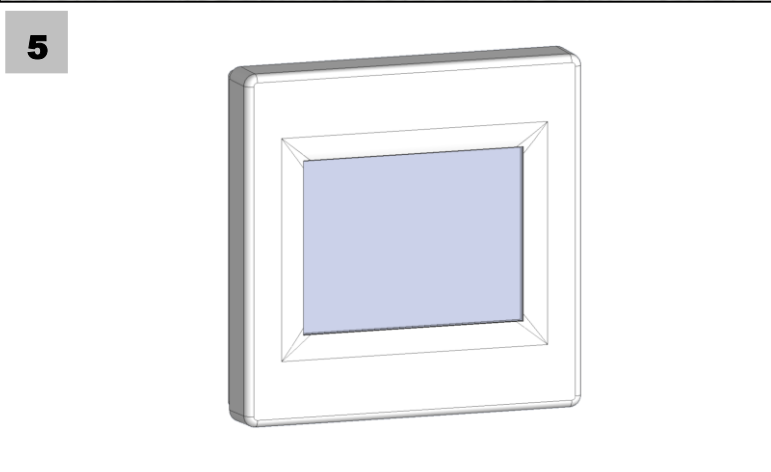
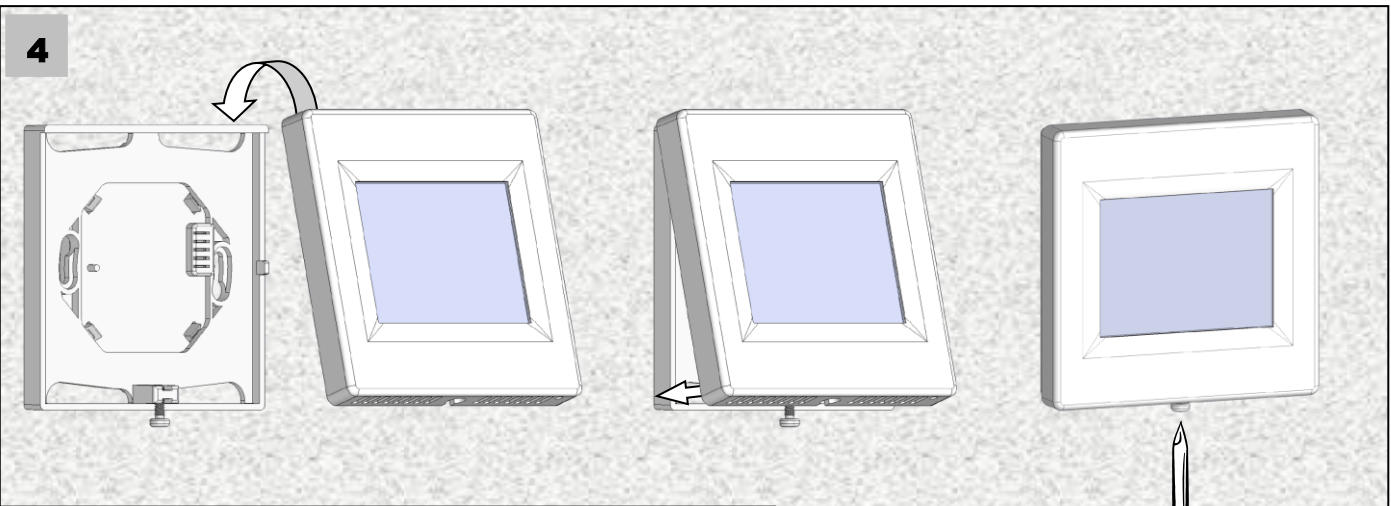
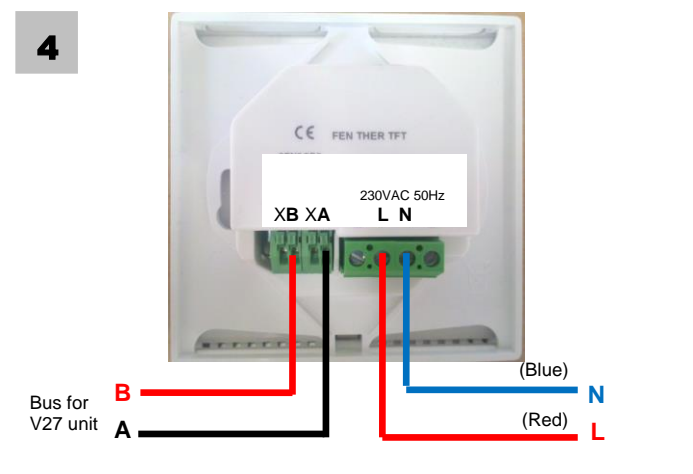
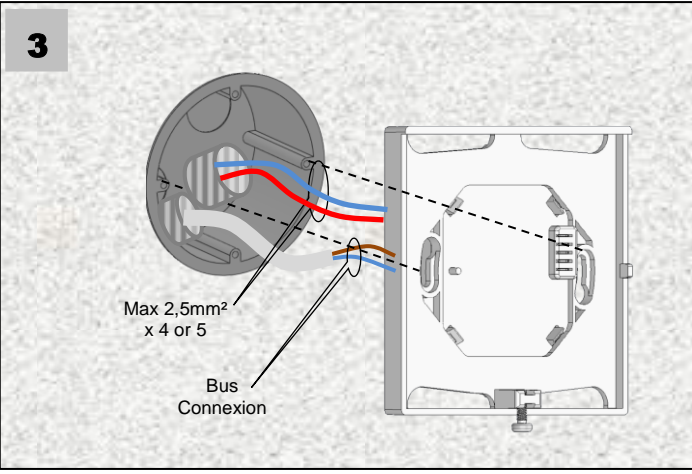
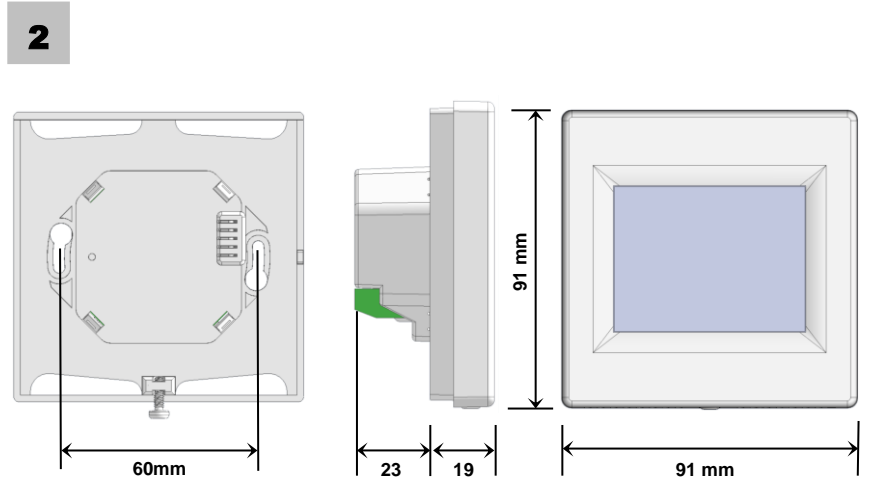
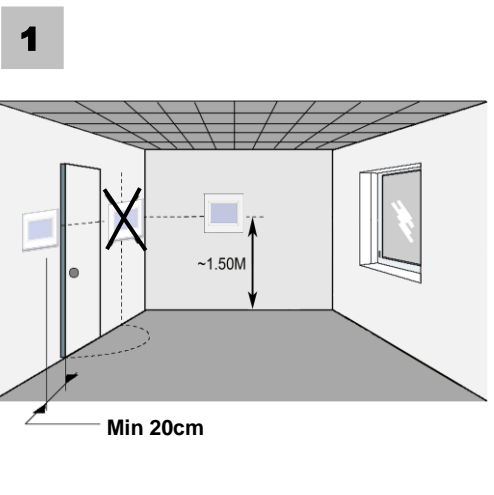

V range Installation Example

